

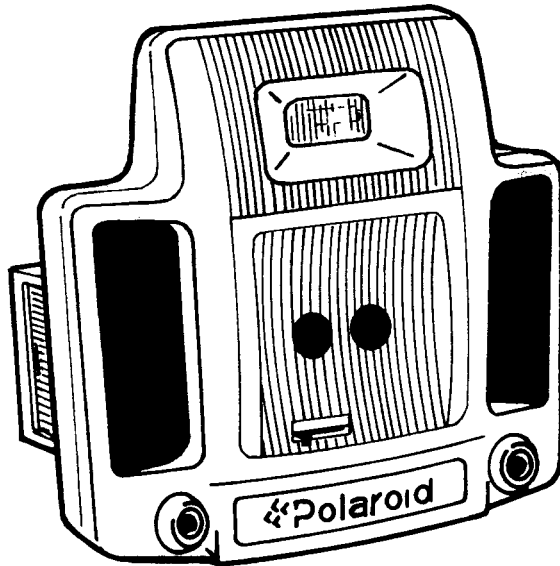

MiniPortrait Camera Model 205

User Manual



Radio and television interference

FCC Notice (U.S.A. only)

This equipment has been tested and found to comply with the limits for a Class B digital device, pursuant to Part 15 of the FCC Rules. These limits are designed to provide reasonable protection against harmful interference when the equipment is operated in a residential environment.

This equipment generates, uses, and can radiate radio frequency energy and, if not installed and used in accordance with the instruction manual, may cause harmful interference to radio communications.

However, there is no guarantee that interference will not occur in a particular installation. If this equipment does cause harmful interference to radio or television reception, which can be determined by turning the equipment on and off, the user is encouraged to try to correct the interference by one or more of the following measures:

- Reorienting or relocating the receiving antenna of the radio or television set
- Increasing the separation between this equipment and the radio or television receiver
- Connecting this equipment to an outlet on a circuit different from that to which the receiver is connected
- Consulting the dealer for help

Note: Changes or modifications not expressly approved by the party responsible for compliance could void the user's authority to operate this equipment.

EMI Notice (Canada)

This Digital Apparatus does not exceed the Class B limits for radio noise emissions from digital apparatus set out in the Radio Interference Regulations of the Canadian Department of Communications.

EMC Notice (Germany)

Polaroid garantiert, daß dieses Gerät die nachstehend aufgeführten Internationalen Standards erfüllt:

- die Vorschriften für RF-Störungen laut EN55022 Klasse B -
- die Anforderungen für Funkenschutz laut EN50082-1, IEC 801-2, IEC 801-3, IEC 801-4.

Table of contents

Certifications	2
----------------	---

1 Setting up

Using this guide	5
Unpacking the camera	6
The camera	7
Setting up the work area	8
Setting up the camera	9
Technical Assistance	10

2 Loading film

Inserting fresh film	12
Removing spent film	14
Cleaning the rollers	15
Cleaning the film exit door	16

3 Taking a picture

Preparing the camera	18
Taking the photo	20

4 Using the camera menus

Using the menu buttons	24
Understanding the options	25

5 Troubleshooting

Correcting common errors	27
--------------------------	----

Polaroid Warranty and Service

MiniPortrait 205 Camera warranty	29
MiniPortrait 205 Camera service	30
Polaroid Offices and Service Centers	31

1 Setting up

The Polaroid MiniPortrait 205 Camera lets you quickly and easily take instant photos for use with ID systems. You can use the camera to take ID photos for use on passports, identification cards, credit cards, and many other small formats.

Using this guide

This guide describes all the features of the Polaroid Mini Portrait 205 Camera. It takes you from unpacking the box to setting up the camera, through troubleshooting problems you may have with photos.

This guide is written for the person who will be setting up and running the camera. You do not need to have any prior knowledge of Polaroid cameras in order to use this new portrait camera.

Unpacking the camera

The following figures illustrate the standard parts you will find in the camera box, in addition to this manual. If you are missing anything, contact your dealer or Polaroid Customer Support at (800) 343-5000 immediately.

a MiniPortrait 205 Camera (**a**)

b an AC adapter

depending on the configuration ordered, you may receive the wall-mounted unit for 110V (**b**) or, for all other voltages, the table-top unit (**c**)

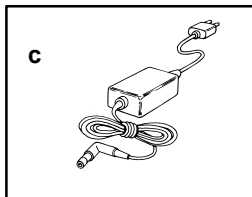
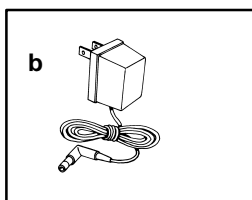
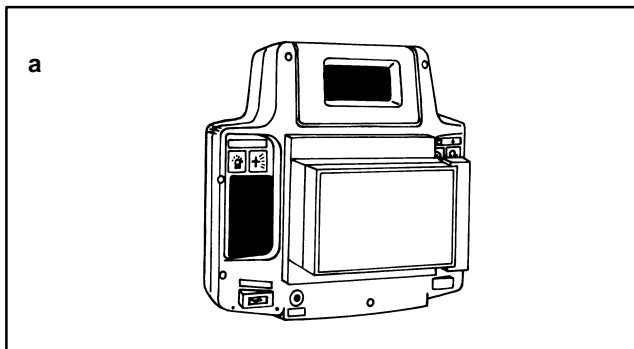

The camera

The following illustrates the parts of the camera.

- | | |
|--------------------------------|-----------------------------------|
| a Display | i Face Brightener button |
| b Menu icon | j Aiming button |
| c Up icon | k Exit con |
| d Shutter button | l Down icon |
| e On button | M Flash |
| f Camera back | n Lenses |
| g AC adapter socket | o Aiming lights |
| h Aiming light selector | p Aperture selector switch |

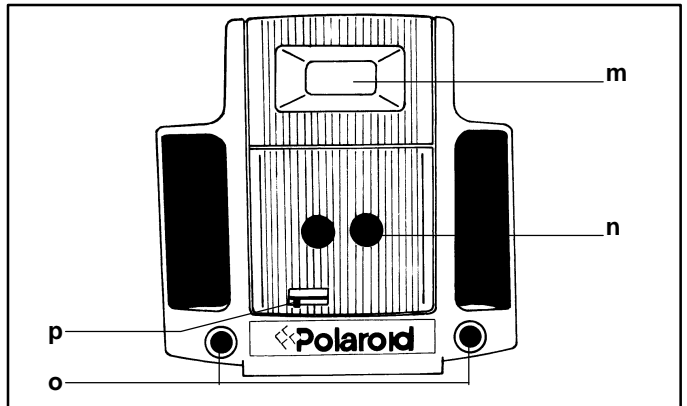
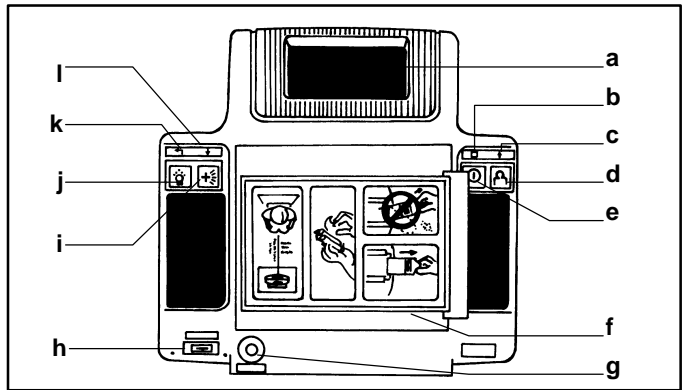

Setting up the work area

You need the following items when setting up your work area:

- the camera
- a wastebasket
- a non-reflective cloth backdrop for ID photos
- a white backdrop for passport photos
- a chair, 17 to 18 inches (45cm) high

To set up the work area for the MiniPortrait Camera (a):

- 1 Use a work area that measures 8 X 10 feet (2.4 X 3m).
- 2 Make sure an electrical outlet (b) is accessible to the camera. Avoid placing the camera where it may be exposed to extreme temperatures, for example, near a door or window.
- 3 Use a wastebasket (c) for discarding tabs and film waste.
- 4 Place the backdrop (d) behind where the subject will be seated. Passport regulations require a white background. For ID pictures hang a piece of non-reflective cloth as a backdrop.
- 5 Place a chair (e) against the backdrop.

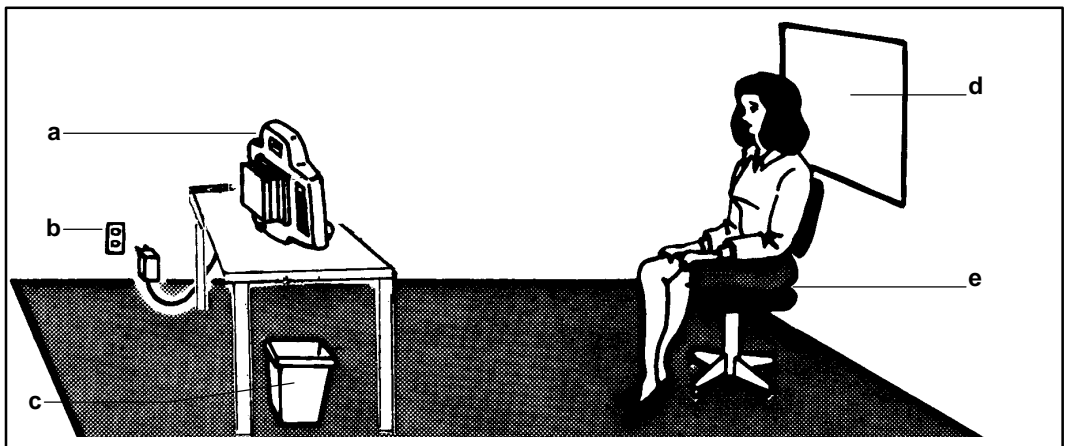

Setting up the camera

Setting up the camera is simple; just follow these steps and you'll have your MiniPortrait 205 Camera set up and ready to take photos in no time.

Note: The following instructions refer to the callouts in the illustrations in the section, *The camera*, earlier in this chapter.

Preparing the camera

To set up the camera:

- 1 Power up the camera by plugging the small end of the AC power cord into the socket on the back of the camera (**g**). Plug the other end of the cord into a grounded AC outlet.

The display reads *Load Film* if the camera does not contain film. If the camera contains film, the display reads "Wait" for a warm-up period of about 15 seconds. After warm-up, it reads *Ready*.

- 2 Adjust the aperture switch (**p**) on the front of the camera for the recommended f-stop. To adjust the aperture switch, move the switch to the desired setting.

Film Speed	Aperture
ASA 80	f11-1/2
ASA 100	f11-1/2
ASA 125	f16
ASA 3000	f64

Note: Use these settings at 75°F (24°C) and above. At colder temperatures, you may have to adjust the settings. Refer to the film instructions for details.

- 3 Set the aiming light switch (**h**) to the passport (PP) or ID setting.

- 4 Use the camera's menu system to adjust the flash exposure, number of exposures, and development time.

For detailed instructions on using the camera's menus, see *Chapter 4, Using the camera's menus*.

Technical Assistance

For technical assistance, call toll-free within the U.S.A.: 1-800-343-5000, Monday through Friday, 8 a.m. to 8 p.m. (Eastern Time). Or, write to the Polaroid Resource Center, 201 Burlington Road, Bedford, MA 01730. In Canada, call toll-free: 1-800-268-6970. Outside North America, please contact the office nearest you.

2 Loading film

When you first turn on the camera, the display reads *Load Film*. Loading film into the camera is quick and simple. After you have loaded film a few times, you will not need to refer to these instructions.

This chapter explains how to:

- Insert a fresh film pack
- Remove the spent film pack
- Clean the processing rollers

Inserting fresh film

To insert a fresh film pack:

- 1 Insert a fresh film pack into the camera back with the black paper tab facing you.

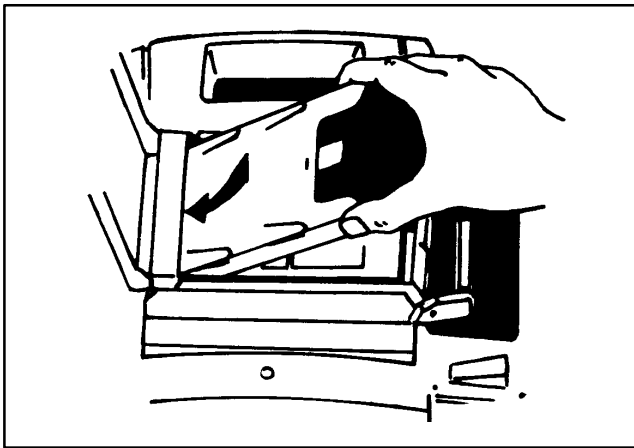

- 2 Check below the black tab to make sure you see a number of white tabs. One white tab is used for each film exposure.

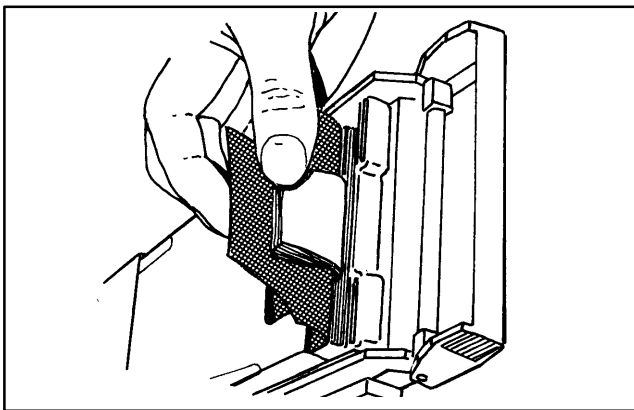

- 3 Close the camera back and rotate its latching cover, making sure the black paper tab is outside the camera back.

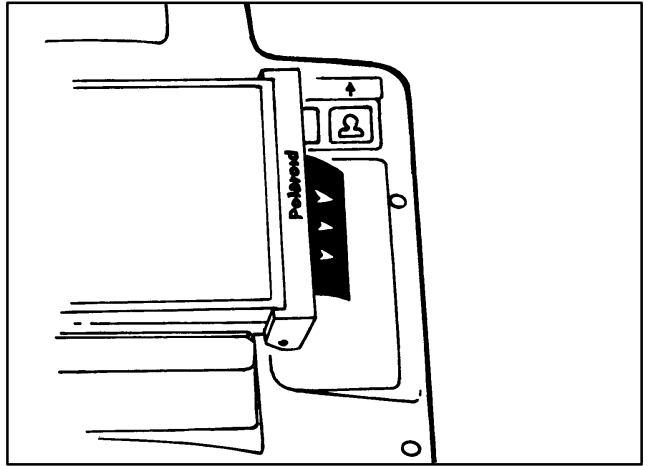

- 4 Pull the black paper tab out of the camera back, keeping the tab perpendicular to the camera at all times. The best method is to place the camera on a flat surface, grip the camera with your left hand and pull the tab with your right hand. This ensures that the film in the camera remains aligned.

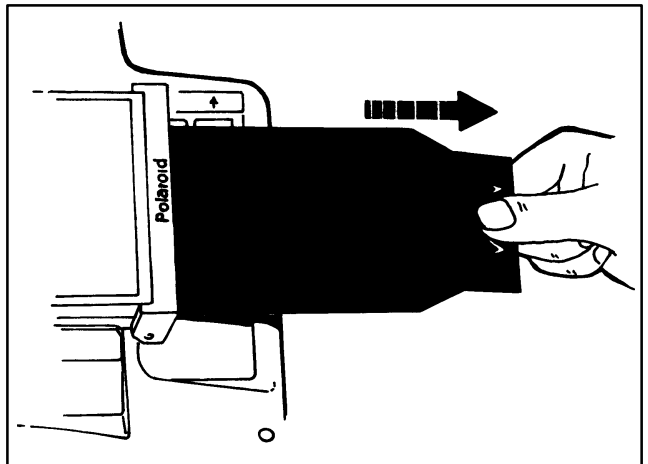

Removing spent film

To remove the spent film pack:

- 1** Open the film compartment and swing open the hinged camera back door to access the spent film pack.
- 2** Remove the empty film pack by grasping it at the tab end, pulling it up and lifting it out (see the first illustration on page 12).

Cleaning the rollers

Clean the rollers each time you replace a film pack. To clean the rollers:

- 1 Open the door of the camera back.
- 2 Remove the rollers by placing your thumbs at the ends of the roller assembly and rotating it upward.

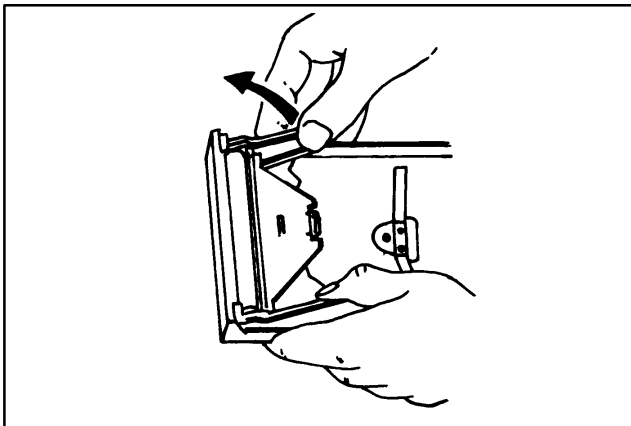

- 3 While the rollers are out of the camera back, wipe them gently with a clean, lint-free cloth moistened with water.

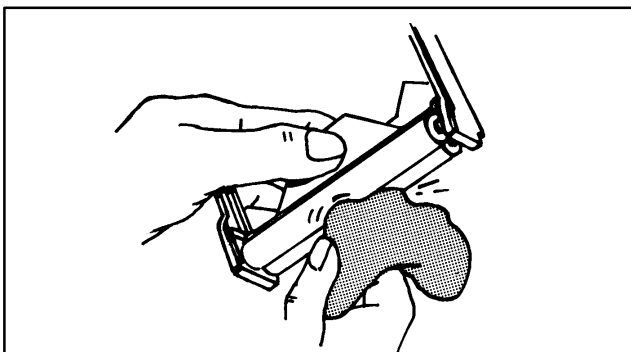

- 4 Replace the rollers by placing the assembly against the film exit door and rotating it downward.

Cleaning the film exit door

Check the film exit door and remove any pieces of paper or dried film developer.

3 Taking a picture

Taking pictures with the Polaroid MiniPortrait 205 Camera is simple. It requires only a few steps to produce high quality passport or ID photos.

This chapter describes the steps you should take each time you take a photo. The first few times you use the MiniPortrait 205 Camera, follow these instructions closely. After you are familiar with the steps, you will be able to take photos on your own. This chapter tells you how to:

- Prepare the camera to take photos
- Take the photo and process the exposed film

Preparing the camera

To prepare the camera to take passport or ID photos:

- 1 Plug the AC power cord into the back of the camera and into a wall outlet. The camera will power up.

The display shows one of two messages. If there is film in the camera, the display reads “Wait” for a warm-up period of about 15 seconds, then it reads *Ready*. If there is no film in the camera, the message reads *Load Film*.

- 2 If necessary, load film into the camera. Refer to *Chapter 2, Loading film* for detailed instructions.
- 3 Place your subject in a chair against the backdrop. For best results, position the subject as close to the backdrop as possible. Remember, passport photos require a white background. For questions regarding passport specifications and techniques, call toll-free: 1-800-343-5000.

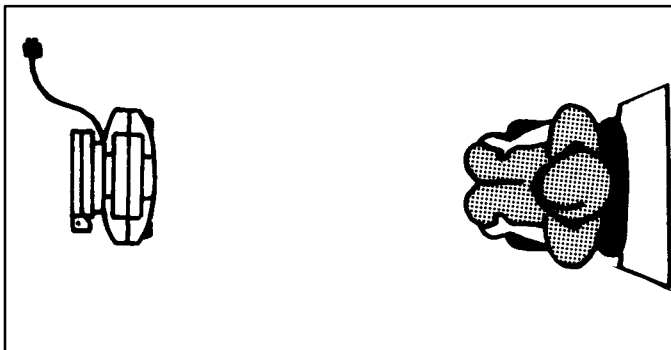

Note: For passport photos, move the aiming light selector to “PP”; for ID photos, set the selector to “ID”. Refer to the section *The camera*, in Chapter 1, for the location of the aiming light selector.

- 4 Press the Aiming button and aim the lights at your subject. The lights blink for 15 seconds while you aim the camera.

Note: The aiming lights must be blinking in order for you to take a picture.

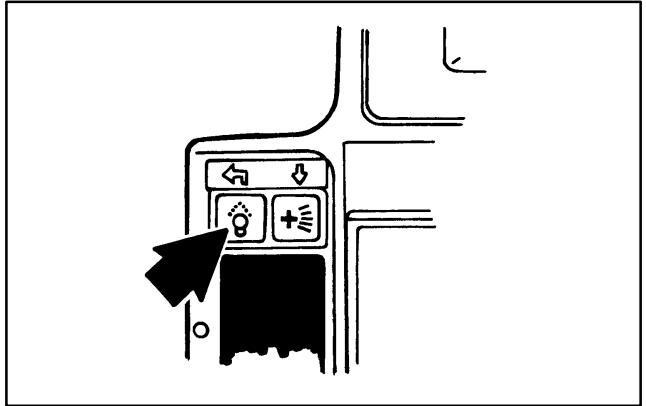

- 5 Position the camera so that the lights converge on your subject's chin.

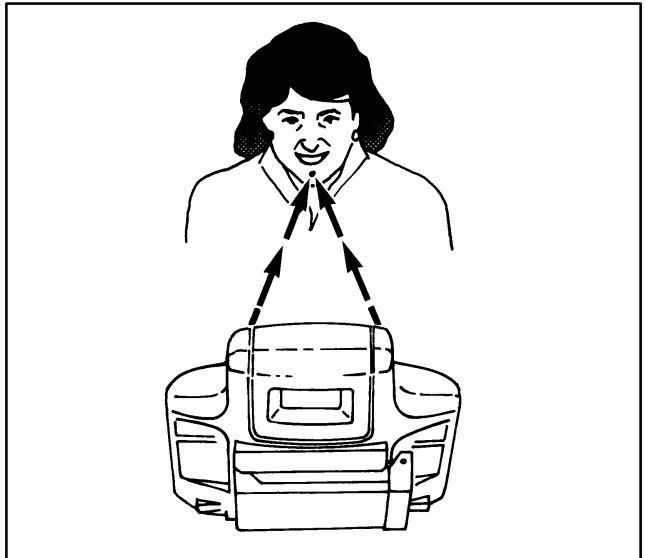

- 6 If your subject has a dark complexion, press the Face Brightener. Refer to *The camera*, in Chapter, 1 for location of the Face Brightener. A Face Brightener icon appears on the display when you press the button. The Face Brightener function turns off and its icon disappears after you take the picture. To turn the Face Brightener function off before you take the picture, press the button again.

When you turn the Face Brightener function on, the camera increases the flash output by 0.3 to 0.5 photographic stops.

Taking the photo

To take a photo:

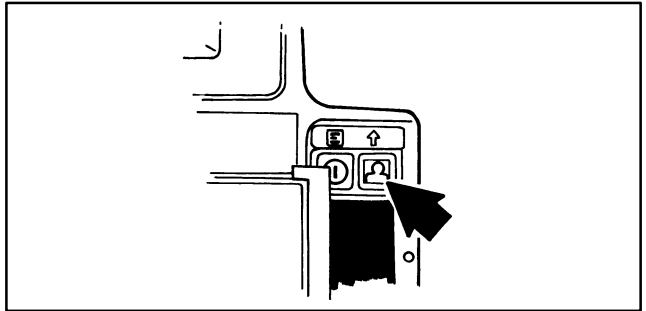

- 1 Press the Shutter button.

After you press the button, the display reads *Pull Film*, or if the camera is set to take another picture on this sheet of film, it reads *Ready*. If it reads *Ready*, take another picture.

Note: You can take the two pictures at the same time, giving you two of the same pose, or you can take one picture after another, giving you two different poses. To set the number of photos to be taken at once, refer to *Chapter 4, Using the camera's menus*.

- 2 To begin processing the film, pull the white film tab, keeping the tab perpendicular to the camera at all times. Rest the camera on a flat surface and pull the tab straight out using the right hand. This ensures that the film in the camera remains aligned.

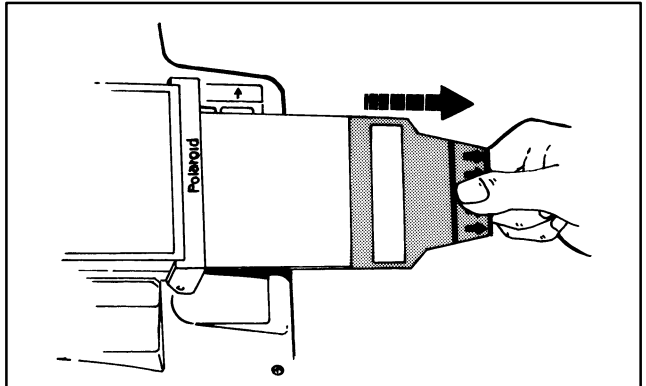
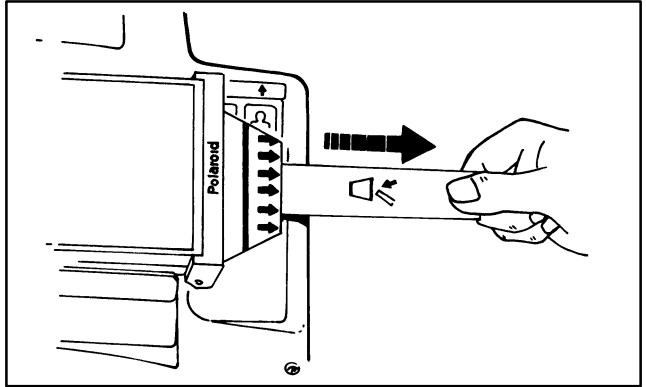

- 3 Pull the yellow tab, keeping the tab perpendicular to the camera. Position the camera and pull the tab as described in 2 above. A smooth, straight pull will prevent blemishes in the picture.

As soon as you pull the yellow tab, the camera starts counting the exposure time of the film. In addition, the number of the exposure currently being timed blinks on the display.

- 4 When the camera timer beeps, peel the back from the print.

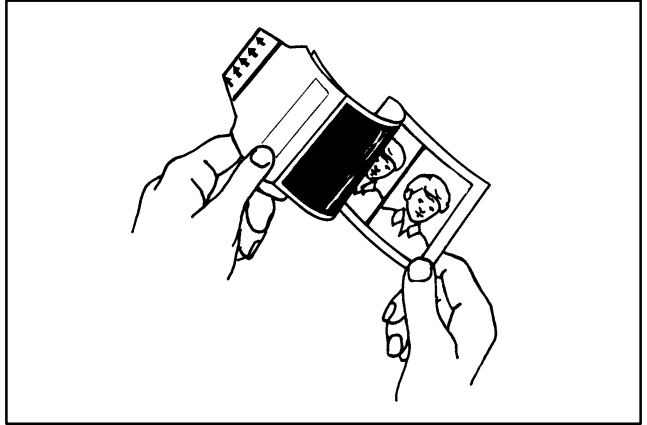

You can lighten or darken your picture by adjusting the aperture selector and/or the flash exposure setting (using the program menu). To lighten the picture, move the aperture selector to the left or increase the flash exposure. To darken the picture, move the aperture selector to the right or decrease the flash exposure.

4 Using the camera menus

The Polaroid MiniPortrait 205 Camera has a menu system that allows you to adjust the functions of the camera. You can set up the camera to work in the way you prefer.

This chapter covers the following:

- Using the menu buttons
- Understanding the menu options

Using the menu buttons

The buttons that you use to operate the camera's menus are located at the top of the back of the camera. They are usually called the On, Aiming, Face Brightener, and Shutter buttons. However, when you are using the camera's menus, the four buttons control alternate functions.

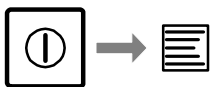

To enter the menu system, press the On button. Once you press the On button, the display shows the camera's menus. The On button now controls the Menu functions. Press the Menu button to select each subsequent menu. Pressing and holding the Menu button allows you to scroll quickly through the menu choices.

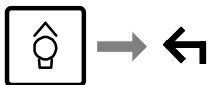

When you are using the camera's menus, the Aiming button controls the Exit function. To move out of the menu system, press the Exit button.



When you are using the camera's menus, the Face Brightener button controls the Down function. To make adjustments within your menu choice, press and hold the Down button.

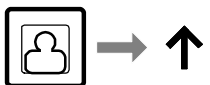

When you are using the camera's menus, the Shutter button controls the Up function. To make adjustments within your menu choice, press and hold the Up button.

Understanding the options

There are seven menu options. They are:

- Counts
- Exposure
- Picture Select
- Development Time
- Reset Counts
- Language
- Auto Shutoff

Counts

The Counts menu item shows two readings from the camera: Film and Flash. The number under the word Film reports the number of sheets of film that have been pulled from the camera. The number under the word Flash indicates the number of times the flash has fired. You cannot make any adjustments to this screen.

Exposure

To move from Counts to Exposure, press the Menu button. The display shows the range of exposure settings. You can set the camera to one of seven exposure settings. To increase exposure, press the Up button. To decrease the exposure, press the Down button.

Picture Select

To move from Exposure to Picture Select, press the Menu button. The display shows the number of pictures the camera is set to take. Press either the Up or Down button to select the number of pictures. The display changes to indicate the number of pictures that the camera will take with each press of the Shutter button.

Development Time

To move from Picture Select to Development Time, press the Menu button. The display shows the number of seconds set for development time. To increase the development time, press the Up button. To decrease the development time, press the Down button.

Reset Counts

To move from Development Time to Reset Counts, press the Menu button. To reset the Counts display (described earlier) to all zeros, press the Up or Down button.

Language

To move from Reset Counts to Language, press the Menu button. The display shows the language set for display messages. Press the Up or Down buttons to select the language you want the camera to display.

Auto Shutoff

To move from Language to Auto Shutoff, press the Menu button. The display shows the current setting for Auto Shutoff time. You can program the camera to shut off automatically when it has been idle for the displayed amount of time. When Auto Shutoff is set to 10 minutes, the camera shuts off if it has not been used for 10 minutes. When Auto Shutoff is set to 20 minutes, the camera shuts off if it has not been used for 20 minutes. When it is set to OFF, the camera remains on until it is unplugged.

Exit

To move from Auto Shutoff out of the menu system, press the Menu button. The display changes from the cameras menus to the *Ready* message. At any time while using the camera menus, you can press the Exit button to leave the menus.

5 Troubleshooting

Correcting common errors

From time to time you may observe faults with your photos. The following information will help you solve problems you may encounter.

Picture Fault	Cause	Corrective Action
Repeated, evenly spaced spots	Dirty developer rollers.	Clean developer rollers.
Missing corners, or orange-red marks along edges	Pull the film tab from the camera at an angle.	Pull the yellow/black film tab straight from the camera.
	Dried developer on rollers.	Clean the rollers.
Rectangular outline in print	The white leader was not pulled completely off prior to pulling the film tab; white tab passed through the rollers with film.	Pull white tab completely out of the camera before pulling the film from the camera.

Picture Fault	Cause	Corrective Action
Small, white specks, pink lines, streaks or blotches	Pulling the film through the rollers too fast.	Pull the film using a smooth, even, moderate pull speed.
Muddy-looking print	Development time not long enough.	Develop film for time recommended in film instruction sheet.
Broad streak or mark across the picture	Hesitating while pulling the film from the camera.	Pull the film tab straight out in one motion, without hesitation.
Very light or no image	Film fogged or extremely overexposed.	Do not remove the safety cover prior to loading the film. Do not open the camera and remove the film pack while taking a picture.

MiniPortrait 205 Camera warranty

Polaroid Corporation warrants the MiniPortrait 205 Camera against defects in manufacture or workmanship for a period of one year from the date of purchase. To verify the warranty period, you should keep the invoice, sales receipt, or other proof of the purchase date.

Should this product or any component or accessory included with it, except software, prove to be defective at any time during the warranty period, Polaroid Corporation will, at its discretion, either replace or repair this item, without charge.

This warranty does not cover damage caused by accident, incorrect installation, unauthorized modification, and misuse or abuse. A charge will be made for repair of such damage.

This warranty excludes all consequential damages and does not affect your statutory rights. Some jurisdictions do not allow the limitation or exclusion of consequential damages, so the foregoing may not apply to you.

MiniPortrait 205 Camera service

U.S.A. and Canada

If your MiniPortrait 205 Camera requires service, call Polaroid Technical Assistance toll-free from within the U.S.A. at **1-800-343-5000**, Monday through Friday, 8 a.m. to 8 p.m., (Eastern Time). From Canada, call toll-free at **1-800-268-6970**.

To return the camera for service, pack it carefully in its original shipping carton or other sturdy container, with plenty of padding. Shipping instructions will be provided by your Polaroid Technical Assistance specialist.

Outside North America

Please contact your nearest Polaroid dealer (see the section immediately following).

Polaroid Offices and Service Centers

Australia

Polaroid Australia Pty Ltd
13-15 Lyonpark Road
PO Box 163
North Ryde, NSW 2113
Tel.: (02) 950 7000
Fax: (02) 887 2209

Belgique/Beigië

Polaroid (Belgium) S.A.-N.V.
rue Colonel Bourg 111
Kolonel Bourgstraat 111
1140 Bruxelles-1140 Brussel
Tel.: 32 2 702 86 20
Fax: 32 2 726 92 99
Toll free line: 32 2 78 155 905

Brasil

Polaroid do Brasil Ltda.
Av. Paulista, 1776/11^a andar
Cerqueira Cesar
São Paulo - Capital
01310-921
Tel.: 55.11.285.6411
Fax: 55.11.287.5393

Canada

Polaroid Canada Inc.
350 Carlingview Drive
Etobicoke, ON M9W 5G6
Tel.: 1 416 675 3680
Fax: 1 416 675 4245
Toll free: 1-800-268-6970

Danmark

Polaroid a.s.
Blokken 75, 3460 Birkerød
Tel.: 45 42 81 75 00
Fax: 45 42 81 70 26

Deutschland

Polaroid GmbH
Sprendlinger Landstrasse 109
63069 Offenbach
Tel.: 49 69 840 4100
Fax: 49 69 840 4204

España

Polaroid (España), S.A.
Calle Orense 16, 2^a planta.
28020-Madrid, Spain
Tel.: 34-1-597 02 52
Fax: 34-1-597 27 82

France

Polaroid (France) S.A.
12 Bis Ave. Gay Lussac78391
La Clef de Saint-Pierre, B.P. 7
78996-Elancourt Cédex
Tel.: 33 1 30 68 38 38
Fax: 33 1 30 68 38 39

Great Britain

Polaroid (U.K.) Ltd. &
Polaroid Export Operations
Wheathampstead House
Codicote Road
Wheathampstead
Hertfordshire AL4 8SF
Tel.: 44 1582 632000
Fax: 44-1582 632001

Hong Kong

Polaroid (Far East) Ltd.
32/F Windsor House
311 Gloucester Road Causeway Bay
Tel.: (852) 2894 0333
Fax: (852) 2895 1382

Italia

Polaroid (Italia) S.p.A.
Via Piave 11
21051 Arcisate (Varese)
Tel.: 39 332-470031
Fax: 39 332-478249

Japan

Nippon Polaroid
Kabushiki Kaisha
Mori Building, No. 30
2-2 Toranomom 3-chome
Minato-ku, Tokyo (105)
Tel.: 81-3-3438-8811
Fax: 81-3-3433-3537

México

Polaroid de México S.A. de C.V.
Paseo de la Reforma 195-Piso 17
C.P. 06500 México, D.F.
Tel.: 52 5 703-1111
Fax: 52 5 566-0505
Del interior al 91 (800) 70-727
Ventas 91 (800) 70-747

Nederland

Polaroid Nederland B.V.
Zonnebaan 45
3606 CH Maarssen
Tel.: 31-30-2410-420
Fax: 31-30-2411-969

Reparaties:

Polaroid (Europa) B.V.
Hoge Bothofstraat 45
7511 ZA Enschede
Tel.: 31 53 4865 400

New Zealand

Polaroid New Zealand Ltd
Camera Services
24-26 Anzac Avenue
Auckland
Tel.: (64 9) 377 3773

Norge

Polaroid (Norge) A/S
Industriveien 8B
1471 Skårer
Tel.: 47 67 90 47 10
Fax: 47 67 90 51 73

Österreich

Polaroid Ges.m.b.H.
Eitnergasse 5A
1231 Wien
Tel.: 43 1 869 86 27
Fax: 43 1 869 81 00

Portugal

Polaroid (Espanña) S.A.
Sucursal em Portugal
Edificio Monumental
Avenida Praia da Vitória 71-A, 4^ºB
1050 Lisboa
Tel.: (35 1) 316.10.49
Fax: (35 1) 316 10 56

Puerto Rico

Polaroid Caribbean Corporation
Centro de Seguros
Ave. Ponce de León 701,
Miramar, Santurce 00907
Tel.: (1 809) 725-6240
Fax: (1 809) 725-5462

Schweiz/Suisse/Svizzera

Polaroid AG
Hardturmstrasse 133
8037 Zürich
Tel.: (41 1) 277.72.72
Fax: (41 1) 271 38 84

Suomi

Polaroid Oy
Sinikalliontie 10
02630 Espoo, Finland
Tel.: 358 0:-502 35 33
Fax: 358 0 502 35 50

Sverige

Polaroid AB
Ekholmsvägen 36, Box 204
127 24 Skärholmen, Sweden
Tel.: 46 8-710 08 50
Fax: 46 8-740 73 68

U.S.A.

Polaroid Corporation
Technical Assistance
Toll Free: 1-800-343-5000